

STUDIO SERVICES

8+



TRANSFORMERS  
RISE OF THE BEASTS

BUMBLEBEE

TRANSFORMERS

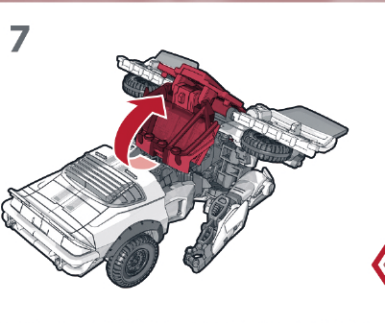
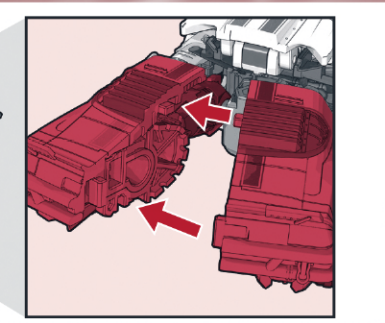
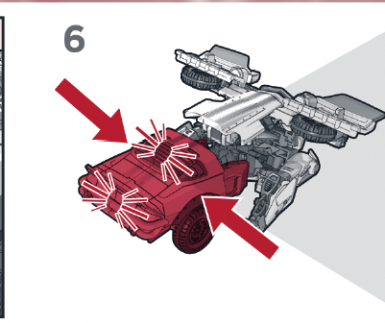
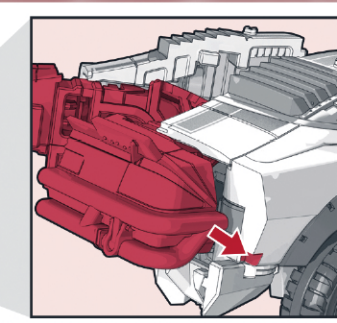
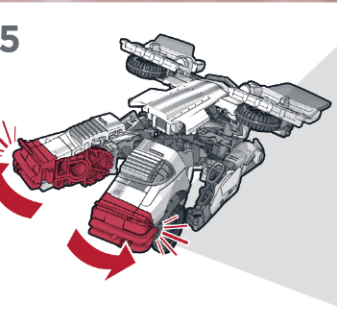
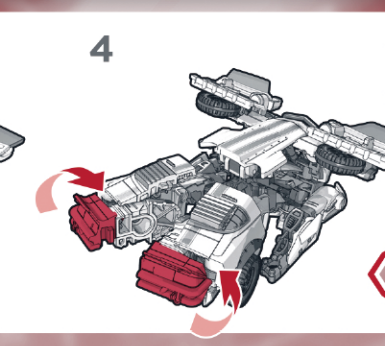
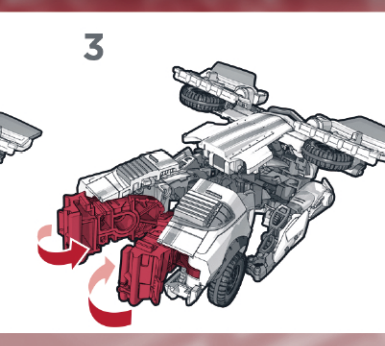
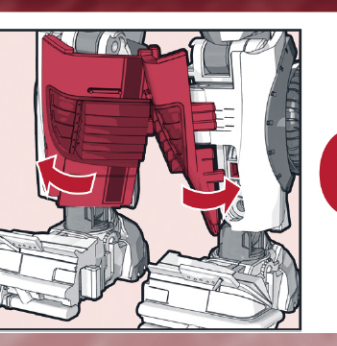
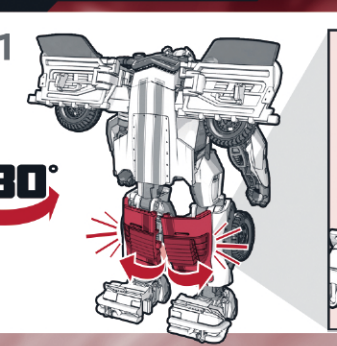
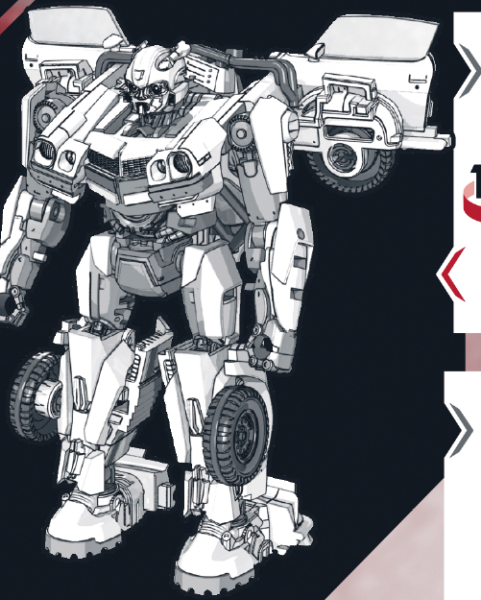
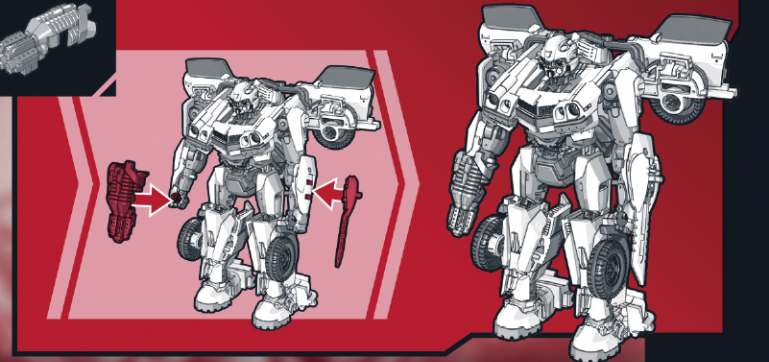
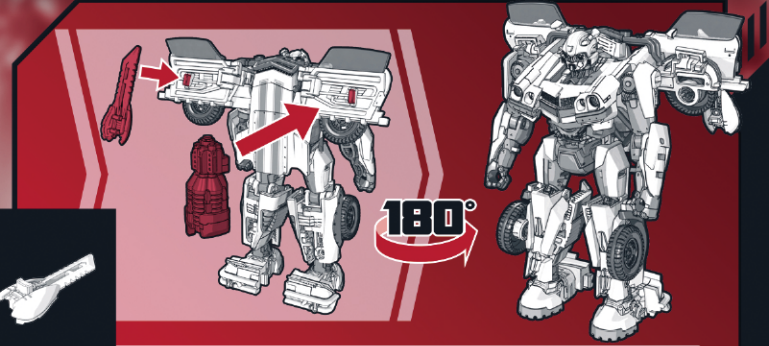

(en) Retain instructions for future reference. (fr) Conservez ces instructions pour référence ultérieure. (de) Bitte die Anleitung für spätere Rückfragen aufbewahren. (es) Conserve estas instrucciones para futuras referencias. (pt) Guardar instruções para eventuais consultas. (it) Conserva le istruzioni come futuro riferimento. (nl) Bewaar de gebruiksaanwijzing om later nog eens te lezen. (sv) Spara instruktionerna för att kunna hänvisa till dem i framtiden. (da) Gem vejledninger til fremtidig referencebrug. (no) Ta vare på disse instruksjonene for fremtidig referanse. (fi) Säilytä nämä tiedot tulevaa tarvetta varten. (el) Φυλάξτε τις οδηγίες για μελλοντική αναφορά. (pl) Zachowaj instrukcje na przyszłość. (hu) Őrizd meg a használati útmutatót. (tr) İleride başvurmak üzere talimatları saklayın. (cs) Tyto informace uschovejte pro budoucí použití. (sk) Návod si odložte na použitie v budúcnosti. (lv) Pāstreažā instrukciju nēlenu a le consulta ģn viitor. (ru) Сохраните инструкцию для будущего использования. (bg) Запазете инструкциите за бъдещи справки. (hr) Sačuvajte upute za buduću upotrebu. (lt) Instrukciją pasilikite ateičiai. (sl) Navodila shranite, mogoče jih boš še potreboval. (uk) Збережіть інструкції для подальшого використання. (et) Jätka juhised edasiseks kasutamiseks alles. (tv) Saglabajiet instrukciju atsaucēi. (ar) احفظ بالتعليمات للرجوع إليها في المستقبل.

CHEVROLET, the BOWTIE logo, CORVETTE and the CORVETTE logo, and CAMARO, are registered trademarks of General Motors, LLC.

Manufactured under license from TOMY Company, Ltd. TAKARATOMY logo is property of Tomy Company, Ltd. TRANSFORMERS and HASBRO and all related trademarks and logos are trademarks of Hasbro, Inc. © 2023 Hasbro.

Hasbro, Pawtucket, RI 02861-1059 USA. HASBRO CANADA, LONGUEUIL, QC, CANADA J4G 1G2. US/CANADA TEL. 1-800-255-5516. Importado por: HASBRO DE MÉXICO, S. DE R.L. DE C.V. Boulevard Manuel Ávila Camacho #32, piso 3, Colonia Lomas de Chapultepec | Sección, Alcaldía Miguel Hidalgo, C.P. 11000, Ciudad de México, México. Centro de Servicio para México: TEL. 5876-2998 y para el interior de la República TEL. 01-800-7-12-62-25. Manufactured by/Produced by: Hasbro SA, Rue Emile-Boéchat 31, 2800 Delémont, CH. Represented by/Reprezentat de: Hasbro, De Entree 240, 1101 EE Amsterdam, NL. © Hasbro UK Ltd., P.O. Box 43, Newport, NP19 4YH, UK. (tr) Üretici Firma Bilgileri: Hasbro SA, Rue Emile-Boéchat 31, 2800 Delémont İsviçre TEL +41 324210800. Hasbro Oyuncak San. ve Tic. A.Ş. tarafından ithal edilmiştir. Tüketici Hizmetleri: Burhaniye Mah. Abdullahağa Cad. No: 51/2 34676 Beylerbeyi İstanbul Türkiye TEL +90 2164229010.



OFFICIAL LICENSED PRODUCT F7237/E0701 Asst. PN00079239

※写真・イラストは実際の商品と異なる場合があります。

